

# Dell FluidFS NAS Solutions NX3600/NX3610 Deployment Guide



# Notes, Cautions, and Warnings



**NOTE:** A NOTE indicates important information that helps you make better use of your computer.



**CAUTION:** A CAUTION indicates either potential damage to hardware or loss of data and tells you how to avoid the problem.



**WARNING:** A WARNING indicates a potential for property damage, personal injury, or death.

© 2013 Dell Inc.

Trademarks used in this text: Dell™, the Dell logo, Dell Boomi™, Dell Precision™, OptiPlex™, Latitude™, PowerEdge™, PowerVault™, PowerConnect™, OpenManage™, EqualLogic™, Compellent™, KACE™, FlexAddress™, Force10™ and Vostro™ are trademarks of Dell Inc. Intel®, Pentium®, Xeon®, Core® and Celeron® are registered trademarks of Intel Corporation in the U.S. and other countries. AMD® is a registered trademark and AMD Opteron™, AMD Phenom™ and AMD Sempron™ are trademarks of Advanced Micro Devices, Inc. Microsoft®, Windows®, Windows Server®, Internet Explorer®, MS-DOS®, Windows Vista® and Active Directory® are either trademarks or registered trademarks of Microsoft Corporation in the United States and/or other countries. Red Hat® and Red Hat® Enterprise Linux® are registered trademarks of Red Hat, Inc. in the United States and/or other countries. Novell® and SUSE® are registered trademarks of Novell Inc. in the United States and other countries. Oracle® is a registered trademark of Oracle Corporation and/or its affiliates. Citrix®, Xen®, XenServer® and XenMotion® are either registered trademarks or trademarks of Citrix Systems, Inc. in the United States and/or other countries. VMware®, Virtual SMP®, vMotion®, vCenter® and vSphere® are registered trademarks or trademarks of VMware, Inc. in the United States or other countries. IBM® is a registered trademark of International Business Machines Corporation.

2013 - 03

Rev. A01

# Contents

<b>Notes, Cautions, and Warnings.....</b>	<b>2</b>
<b>1 PowerVault NX3600/NX3610 NAS Appliance Overview.....</b>	<b>5</b>
Supported Hardware.....	5
Supported Software.....	5
Other Information You May Need.....	5
<b>2 Setting Up The Environment.....</b>	<b>7</b>
Choosing The Switch Topology.....	8
Cabling Overview.....	9
Dedicated SAN High-Availability (Recommended).....	10
Dedicated SAN Solution In The Non-Redundant Option.....	11
All-In-One High-Availability Option.....	12
All-In-One Non-Redundant Option.....	13
Preparing Your Management Station.....	14
<b>3 Running NAS IDU.....</b>	<b>15</b>
Installing NAS IDU.....	15
Launching NAS IDU.....	15
Deploying The NAS Appliance Using The NAS IDU.....	15
<b>4 Setting Up Your MD Storage Solution.....</b>	<b>19</b>
MD Topology.....	19
Enabling Jumbo Frames On The MD Storage Array.....	20
Considerations When Creating Disk Groups And Virtual Disks.....	20
One Disk Group (RAID 6), One Hot Spare.....	20
One Disk Group (RAID 1/10), One Hot Spare.....	21
Two Disk Groups (RAID 5), Two Hot Spares.....	21
Two Disk Groups (RAID 6), Zero Hot Spares.....	22
One Disk Group (RAID 5), One Hot Spare.....	23
Creating Disk Groups.....	23
Creating Disk Groups Automatically.....	23
Creating Disk Groups Manually.....	24
Creating Virtual Disks Using PowerVault MDSM.....	25
For Version 10.80.x6.47 And Earlier.....	25
For Version 10.84.x6.25 And Later.....	25
Creating A Host Group.....	26

Creating A Host.....	26
Adding Virtual Disks To A Host Group.....	27
Accessing The NAS Manager Web Interface.....	27
<b>5 Running The NAS Manager Configuration Wizard.....</b>	<b>29</b>
Configuring DNS.....	29
Configuring NTP.....	29
Configuring SMTP.....	30
Configuring SNMP.....	30
Formatting And Starting The File System.....	30
Creating and Changing Admin Passwords.....	31
Joining The File System To A Windows Active Directory Domain.....	31
Configuring The CIFS Protocol.....	31
Providing UNIX Identity Database Values.....	32
Mapping Users Automatically.....	32
Creating NAS Volumes.....	32
Creating CIFS Shares.....	33
Creating NFS Exports.....	33
Configuring Additional Client VIPs.....	33
Troubleshooting LUNs.....	34
<b>6 PowerVault FluidFS NAS Setup Worksheet.....</b>	<b>35</b>
<b>7 Getting Help.....</b>	<b>37</b>
Contacting Dell.....	37
Documentation Feedback.....	37

# PowerVault NX3600/NX3610 NAS Appliance Overview

The Dell PowerVault NX3600 and NX3610 NAS appliances that work with PowerVault MD32x0i and MD36x0i iSCSI deployments help provide unified storage solutions with access to block and file data. The PowerVault NX3600 series uses the Dell Fluid File System (FluidFS) to enable both performance and capacity to scale without SAN or application downtime.

## Supported Hardware

The following hardware prerequisites are necessary for deploying your solution:

- **Cabling** – Cat 5E or higher for 1 Gb and Cat 6A or higher for 10 Gb.
- **Management Station** – A laptop or workstation.

**Table 1. Supported Hardware**

NX	Number of Supported NAS Appliances	MD Type	Number of Supported Storage Arrays
NX3600 (1 Gb)	1	MD3200i	1
		MD3220i	
NX3610 (10 Gb)	2	MD3600i	2
		MD3620i	
		MD3660i	

## Supported Software

The following software prerequisites are necessary for deploying your solution:

- MD Storage Manager (MDSM) installed on the management station.
- NAS IDU installed on the management station.

 **NOTE:** The software is available for download at [dell.com/support](http://dell.com/support).

## Other Information You May Need

 **NOTE:** Always check for updates on [dell.com/support/manuals](http://dell.com/support/manuals) and read the updates first because they often supersede information in other documents.

Your product documentation includes:

### Getting Started Guide

Provides an overview of system features, setting up your system, and technical specifications. This document is also shipped with your system.

<b>Owner's Manual</b>	Provides information about system features and describes how to troubleshoot the system and install or replace system components.
<b>Administrator's Guide</b>	Provides information about configuring and managing the system.
<b>CLI Reference Guide</b>	Provides information about set of commands to view, edit, add, delete, enable, disable, and set NAS cluster solution entities, such as exports, shares, volumes, and accounts.
<b>System Placemat</b>	Provides information on how to set up the hardware and install the software on your Dell FluidFS NAS solution.
<b>Resource Media</b>	Any media that ships with your system that provides documentation and tools for configuring and managing your system, including those pertaining to the operating system, system management software, system updates, and system components that you purchased with your system.

## Setting Up The Environment

The following are the steps required to set up your PowerVault NX3600/NX3610 NAS Appliance. For more information on each of the steps, see the relevant sections mentioned in the procedure below.

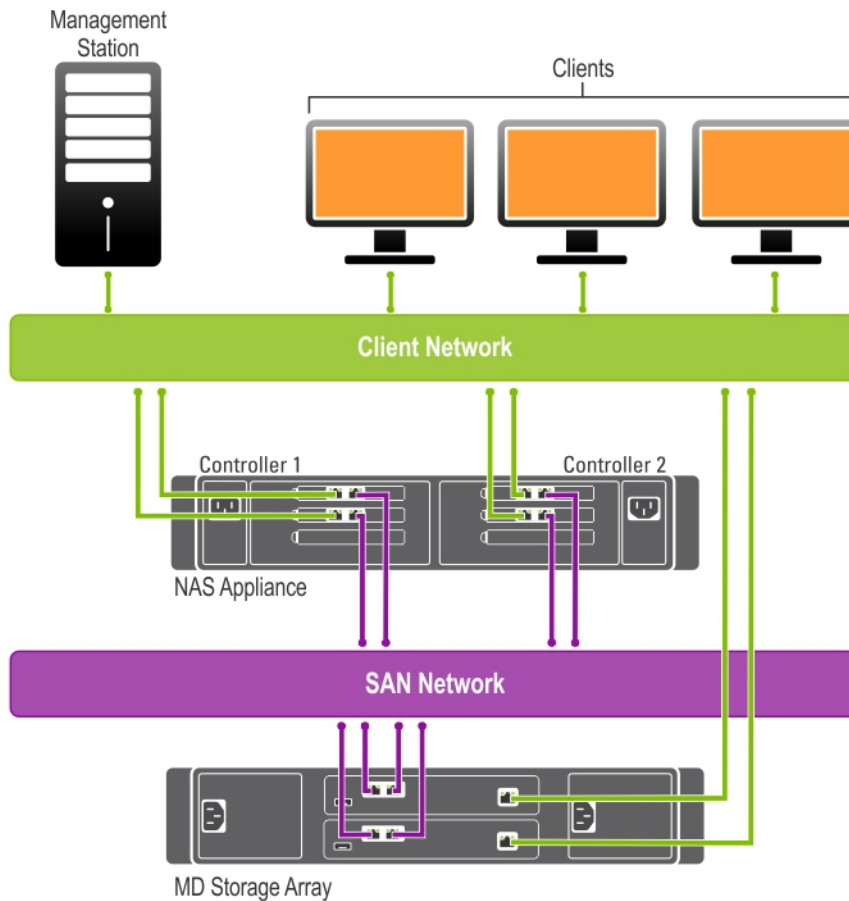

**Figure 1. NAS Appliance – Hardware Overview**

1. Choose the switch topology.  
For more information see, [Choosing The Switch Topology](#).
2. Complete the setting up of your NAS controller(s) in the rack.  
For more information, see the Rack Installation document that was shipped with your system.
3. If required, complete the setting up of your MD storage array(s) and connect the storage array(s) to the NAS controller(s).  
For more information, see the Deployment Guide specific to the MD storage array at [dell.com/support/manuals](http://dell.com/support/manuals).

4. Complete the cabling of the NAS controller(s) and the MD storage array(s) with the management station, SAN network, and the client network.
5. Connect the management station to the same switch as the client connections on your NAS controller(s).  
For more information on cabling for your particular topology, see [Cabling Overview](#).
6. Complete the PowerVault FluidFS NAS Setup worksheet.  
For more information, see [PowerVault FluidFS NAS Setup Worksheet](#).
7. Complete the configuration of your management station.  
For more information, see [Preparing Your Management Station](#).
8. Install and run the NAS IDU on the management station that has IPv6 enabled.  
For more information, see [Running PowerVault NAS IDU](#).
9. Set up your MD storage array using the MDSM.  
For more information, see [Setting Up Your MD Storage Solution](#).
10. Run the NAS Manager Configuration Wizard.  
For more information, see [NAS Manager Configuring Wizard](#).

## Choosing The Switch Topology

The PowerVault NX3600/NX3610 supports multiple switch topologies. Choose the ideal topology for your environment and cable the solution accordingly. For more information on the cabling requirements for each of the topologies, see [Cabling Overview](#).

**Table 2. Switch Topologies for PowerVault NX3600/NX3610 in the Non-Redundant and High Availability Options**

Topology	Number of Switches	Description
Dedicated SAN — High Availability (HA)	4	This topology leverages the best practices of the industry relating to iSCSI and separates the SAN and LAN/Client traffic. The client cables are connected to a client switch and the SAN cables are connected to a SAN switch.   <b>NOTE:</b> Dedicated SAN-High Availability (HA) is the recommended topology.
Dedicated SAN — Non-Redundant	2	
All-in-one solution — HA	2	A basic topology where the SAN and the client cables are connected to the same switch.
All-in-one solution — Non-Redundant	1	

Ensure the following settings are enabled in the SAN and client switches:

**Table 3. Switch Settings**

	Client/Primary Network	SAN Network
Jumbo Frames Enabled (9216 MTU)	Recommended	Required
Portfast Enabled	Required	Required
Flow Control Enabled	Recommended	Required
IPv6	Required (during initial deployment)	Required



**NOTE:** Dell PowerConnect switches must be configured with an MTU size of 9216 or greater to accept frames of size 9000 MTU. Non-Dell switches may require a different MTU configuration for similar frame sizes. For more information on MTU configuration for non-Dell switches, see the switch-specific manual.

## Cabling Overview

The following figures give an overview of the cabling for the Dedicated SAN – High Availability (HA) solution. If one of the non-HA topologies is chosen, instead of splitting the cables between switches A and B, the cables will go to the single switch A.

For example, if you do not use two client switches, all client connection cables will go to client switch A. Cabling illustrations for other available topologies are detailed further down in the document.

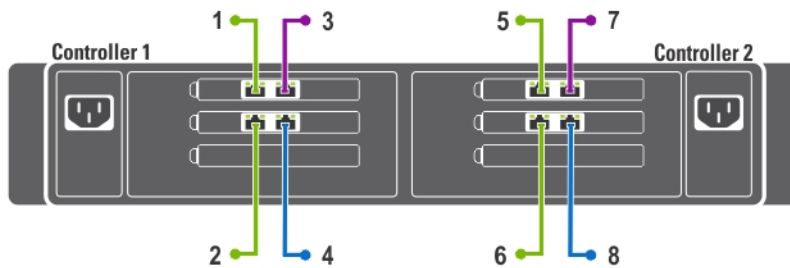

	Description	Connection
1	NAS Controller 1, Client Connection 1	To Client Switch A
2	NAS Controller 1, Client Connection 2	To Client Switch B
3	NAS Controller 1, SAN Connection A	To SAN Switch A
4	NAS Controller 1, SAN Connection B	To SAN Switch B
5	NAS Controller 2, Client Connection 1	To Client Switch A
6	NAS Controller 2, Client Connection 2	To Client Switch B
7	NAS Controller 2, SAN Connection A	To SAN Switch A
8	NAS Controller 2, SAN Connection B	To SAN Switch B
	Management station (not shown)	To Client Switch

Figure 2. NX3600/NX3610 Controller Network Connections

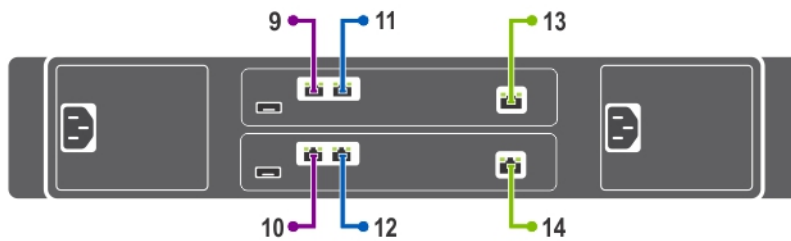

	Description	Connection
9	MD Controller 0, iSCSI Port 0	To SAN Switch A
10	MD Controller 1, iSCSI Port 0	To SAN Switch A
11	MD Controller 0, iSCSI Port 1	To SAN Switch B
12	MD Controller 1, iSCSI Port 1	To SAN Switch B
13	MD Controller 0, Management Port 0	To Client Switch A
14	MD Controller 1, Management Port 0	To Client Switch B

Figure 3. PowerVault MD Network Connections

## Dedicated SAN High-Availability (Recommended)

It is recommended to isolate the SAN traffic from the LAN or client traffic with redundant switches for HA. All the client cables are split between the redundant client switches, and the SAN/Internal network cables are split between the redundant SAN switches. The MD controller management ports are split between the redundant client switches.

**NOTE:** In all HA configurations, the SAN switches must be stacked, lagged (link aggregation), or trunked.

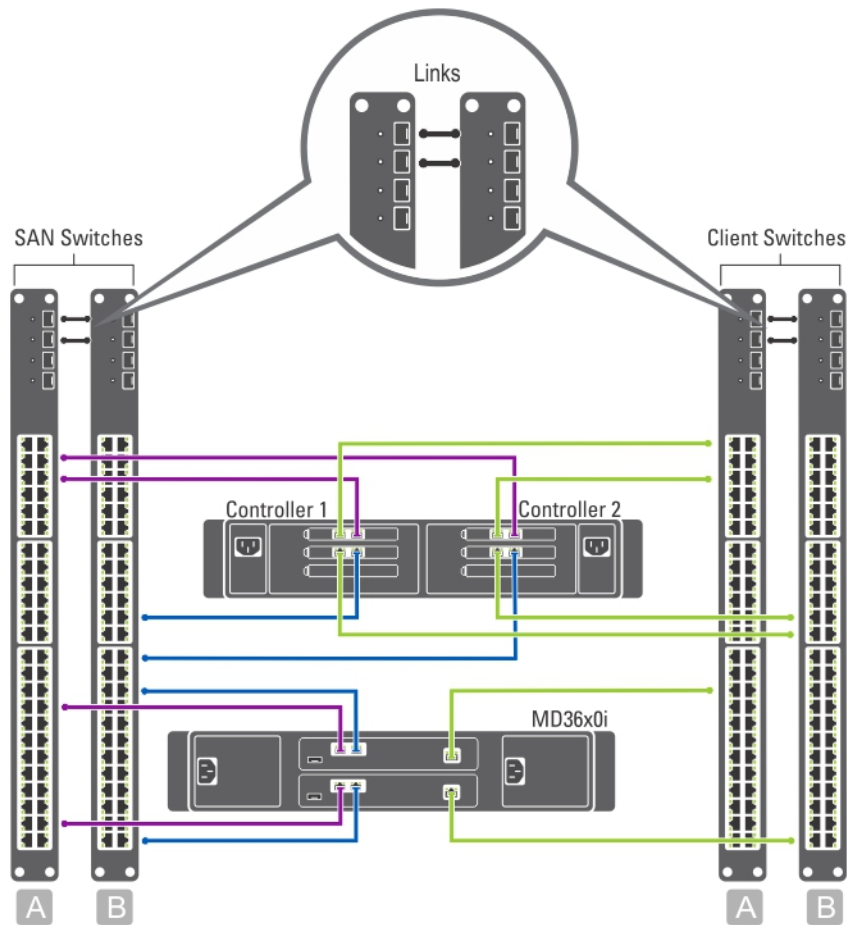



Figure 4. Dedicated SAN Solution in the High Availability Option

 **NOTE:** For more information on the details of cabling the NAS controller(s) and the MD system(s), see [Cabling Overview](#).

## Dedicated SAN Solution In The Non-Redundant Option

The dedicated SAN solution in the non-redundant option isolates the SAN traffic from the client traffic, but without redundant switches. All the client cables are connected to the client switch and the SAN/Internal network cables are connected to the SAN switch.

 **CAUTION:** In this configuration, the switches become a single point of failure.

 **NOTE:** It is recommended that you separate the SAN and client subnets using virtual LANs.

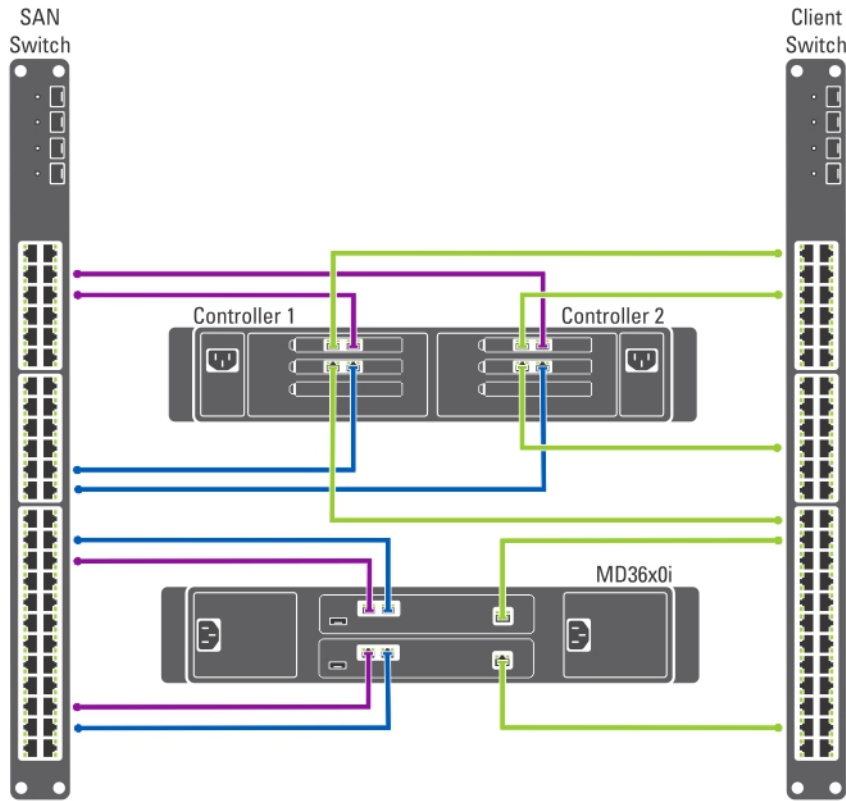

**Figure 5. Dedicated SAN Solution in the Non-Redundant Option**

**NOTE:** For more information on the details of cabling the NAS controller(s) and the MD system(s), see [Cabling Overview](#).

## All-In-One High-Availability Option

In the all-in-one high-availability option, the redundant switches are stacked and host both SAN/Internal and client network traffic. The SAN/Internal and client cables are split between the redundant switches.

**NOTE:** It is recommended that you separate the SAN and client subnets using virtual LANs.

**NOTE:** The switches are stacked, lagged (link aggregation), or trunked.

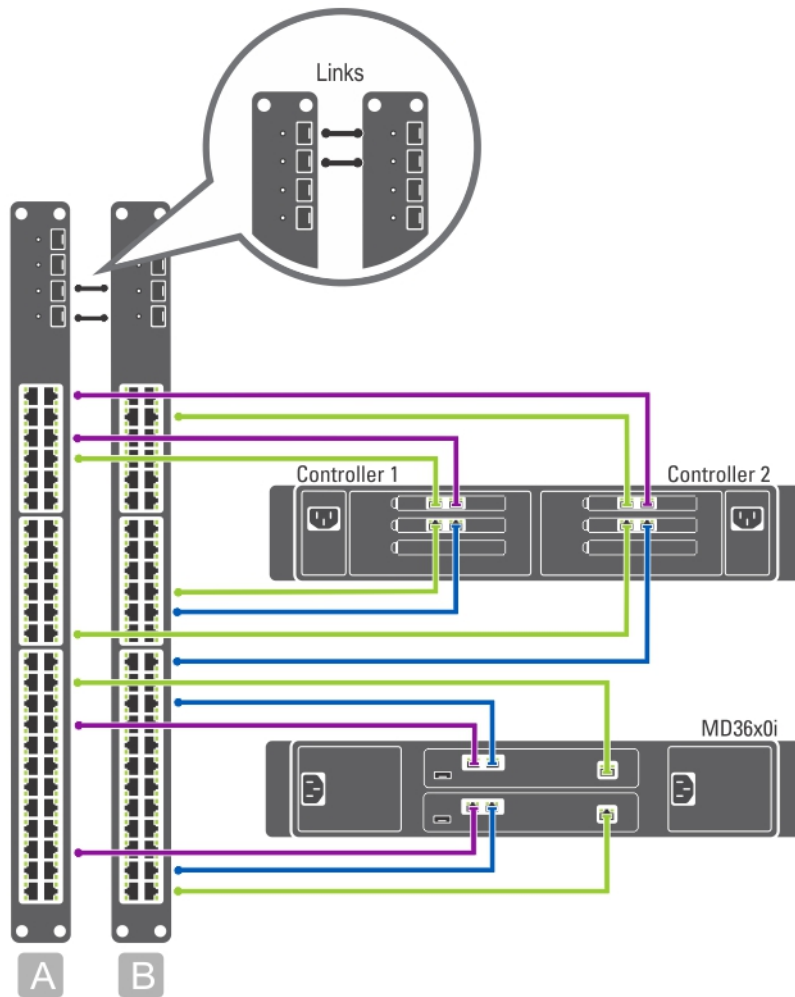





Figure 6. All-in-One High-Availability Option

 **NOTE:** For more information on the details of cabling the NAS controller(s) and the MD system(s), see [Cabling Overview](#).

## All-In-One Non-Redundant Option

In the all-in-one non-redundant option, both the SAN/Internal and client cables are connected to the same switch.

 **CAUTION:** In this configuration, the switch is a single point of failure.

 **NOTE:** It is recommended that you separate the SAN and client subnets using virtual LANs.

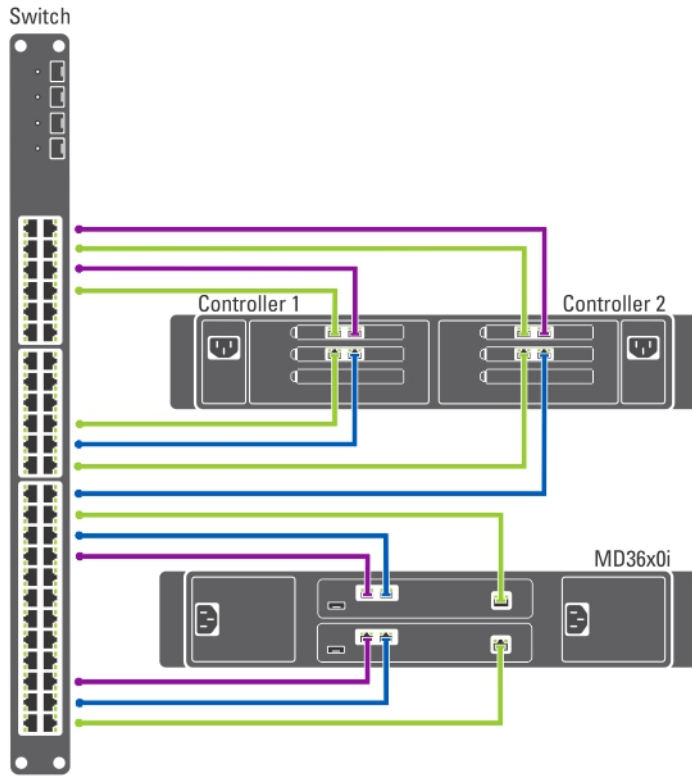

Figure 7. All-in-One Non-Redundant Option

**NOTE:** For more information on the details of cabling the NAS controller(s) and the MD system(s), see [Cabling Overview](#).

## Preparing Your Management Station

A management station is required to manage and configure the NAS cluster solution. The NAS cluster solution can be accessed using either the CLI or the Dell PowerVault NAS Manager.

**NOTE:** You can either log on to the CLI or the NAS Manager. It is highly recommended that you do not attempt to log on to both the CLI and NAS Manager at the same time.

The minimum requirements for the management station are:

- IPv6 must be enabled.
- The NAS Initial Deployment Utility (IDU) must be installed.
  - NOTE:** You can download and install the latest version of the Dell NAS IDU from [dell.com/support](http://dell.com/support).
- The NAS cluster solution must be cabled appropriately and for the initial deployment, both the management station and NAS Appliance(s) must be connected to the same physical client or LAN switch.
- Either Microsoft Internet Explorer or Mozilla Firefox must be installed with JavaScript enabled.
- Modular Disk Storage Manager (MDSM) must be installed to manage the MD storage array.

## Running NAS IDU

The **Dell NAS Initial Deployment Utility (IDU)** guides you through the steps necessary to set up the network configuration and pair the controllers together. It also starts the process of pairing the system to the PowerVault MD32x0i/MD36x0i storage appliances.

Before running the NAS IDU, ensure that:

- You complete the PowerVault FluidFS NAS Setup worksheet to determine your network configuration and IP address allocation for your controllers before executing this utility. For more information, see [PowerVault FluidFS NAS Setup Worksheet](#).
- The NAS IDU is installed and executed from a management station that has IPv6 enabled. The utility connects to and configures your controllers through the link-local IPv6 address. IPv6 can be disabled on the client network after the initial installation and configuration is complete.
  - ✎ **NOTE:** IPv6 must remain enabled in the SAN/Internal switches.
- The management station is connected to the same switch as the client connections on your controllers. For more information, see [Choosing The Switch Topology](#).

## Installing NAS IDU

✎ **NOTE:** Before deploying the NAS IDU, ensure that IPv6 is enabled on all network interface devices connected to the Client or LAN switch(es).

To install the NAS IDU on your management station:

1. Download the NAS IDU installer from [dell.com/support](http://dell.com/support).
2. Double-click on **FluidFS-NAS-IDU-installer.exe**.  
The **NAS Deployment Utility** screen is displayed.
3. Follow the prompts in the installer to complete the installation.

## Launching NAS IDU

To launch the NAS IDU, select **Start** → **All Programs** → **Dell** → **FluidFS** → **NAS Deployment Utility**. The NAS IDU welcome screen is displayed.

✎ **NOTE:** The actual configuration is not applied until all settings are confirmed in the **Configuration Summary** screen.

✎ **NOTE:** Use this utility only to configure unconfigured appliances. Do not attempt to use this utility on fully configured or clustered PowerVault NX3600/NX3610 NAS solutions or to reconfigure IP addresses. This utility does not check for duplicate IPs or null entries.

## Deploying The NAS Appliance Using The NAS IDU

To deploy the NAS appliance:

1. Launch the **NAS Initial Deployment Utility**.

- The **NAS Initial Deployment Utility** screen is displayed.
2. Click **Next**.  
The **NAS Discovery** screen is displayed.
    - All un-configured NAS appliances are displayed in the **NAS Discovery** screen. Select the appropriate NAS appliance model and go to step 8.
    - If un-configured NAS controllers are not discovered automatically, go to step 3.
  3. On the **NAS Discovery** screen, click **Next**.  
The **MAC Controller Discovery** screen is displayed.
  4. Connect a monitor and keyboard to an un-configured controller.  
The **Controller MAC Address** is displayed on the monitor.
  5. On the **MAC Controller Discovery** screen, in **MAC Address**, enter the MAC address that is displayed on the monitor connected to the un-configured NAS controller.
  6. Click **Connect** to test the connection with the controller.
  7. To change the entered MAC address, click **Edit**.
  8. Click **Next**.  
The **NAS Cluster Selection** screen is displayed. The **NAS Controller Discovery** screen displays the controllers of the un-configured NAS appliance, the service tag, and the status of the NAS appliance.
  9. In the **NAS Cluster Selection** screen, click **Next**.  
The **NAS Cluster Identification** screen is displayed.
  10. In **NAS Cluster Name**, enter the name for the NAS cluster and click **Next**.  
The **Network Configuration** screen is displayed.
  11. Enter the following IP addresses, these IPs must reside on the same subnet:
    - **Client VIP**
    - **NAS Management VIP**
    - **Gateway**

 **NOTE:** The Gateway is used as an external quorum device for the NAS solution. Therefore, the primary client network and gateway must reside on the same subnet. If a true gateway does not exist, the gateway field must be a pingable IP address that resides on the client network. Examples are a domain controller, switch, or other device that is reachable at all times by the NAS over the primary client network.

    - **Subnet Mask**

 **NOTE:** The IP addresses for the controllers are assigned automatically by using the Client VIP. For example, if the client VIP is set to *10.10.79.155*, the controller 0 IP will be *10.10.79.156* and so on.
  12. From the **Interconnect Subnets** list, select a subnet that is not being used and does not conflict with any other subnet on your network.  
If the default subnets are not available, you can enter the IP address of the subnet manually.
  13. You can assign the IP addresses of the controllers manually or allow the NAS IDU to automatically assign the IP addresses. To assign the IP addresses for the controllers manually, click **Advanced**.  
The **Client access network** screen is displayed.

 **NOTE:** To allow the NAS IDU to assign the IP addresses automatically, click **Next**. The **NAS iSCSI network** screen is displayed. NAS IDU does not check for duplicate IPs, verify none of the auto-assigned IPs are in use on your network. Proceed to step 18.
  14. Enter the IP address for each controller and click **Next**.  
The **Management network** screen is displayed.
  15. If blank, enter the IP addresses for the **Controllers**, **IPMI**, and **Subnet Mask**.



16. Click **Next**.  
The **Internal interconnect network** screen is displayed.
17. If blank, enter the IP addresses for the **Controllers, Winbind, and Subnet Mask**.  
The **NAS iSCSI network** screen is displayed.
18. Enter the IP addresses for the following:
  - **SAN Network A**
  - **SAN Network B**
  - **Subnet mask**

For SAN Networks A and B, enter the first IP address and as you enter the SAN network IP addresses the **IP Range for Controllers** get updated.

19. To modify the **IP Range for Controllers**, click **Modify** and modify the IP addresses manually.
20. From the **Network MTU list**, select the appropriate MTU.

 **NOTE:** Although the tool allows 1500 MTU, 9000 MTU is required for the SAN network. If MTU 1500 is not configured on the SAN, the NAS reports 15% packet loss.

21. Click **Next**.  
The **iSCSI Target Discovery** screen is displayed.
22. In **iSCSI Discovery Address for MD Array**, enter one of the iSCSI port IP addresses of the PowerVault MD array for the iSCSI target.

 **NOTE:** The NX3610 supports two MD storage arrays. In version 01.01.02.016 of the NAS IDU, if a second array is not attached to the NX3610 cluster, enter the IP address of the single storage array twice.

23. Click **Next**.

 **NOTE:** It is highly recommended to copy the configuration details from the **Configuration Summary** screen and paste it in a different file (.doc or .txt) for future reference.

The **Configuration Summary** screen displays all the configuration details for the selected NAS appliance.

24. Click **Next**.  
The NAS IDU applies the cluster configuration to the selected NAS appliance. After the configuration is complete, the **Configuration Results** screen is displayed. The NAS controller IQNs are displayed in the **Configuration Results** screen.

 **NOTE:** It is highly recommended to copy the NAS controller IQN details from the **Configuration Results** screen and paste it in a different file (.doc or .txt) for future reference. You must match these NAS controller IQNs in the MDSM.

25. Set up your MD storage array using MDSM.  
For more information, see [Setting Up Your MD Storage Solution](#).
26. Click **Finish**.





# Setting Up Your MD Storage Solution

Before following the instructions in this section, ensure that you have discovered and completed the initial configuration (naming, assigning iSCSI, and management port IPs) of your PowerVault MD32x0i/MD36x0i storage arrays in accordance with the topology you plan to use.

This section provides the steps necessary to configure the host group and virtual disks that are required for the NAS cluster solution. For additional information regarding a task such as creating virtual disks, see the PowerVault Modular Disk Storage Manager (MDSM) Help or the Dell PowerVault MD32x0i/MD36x0i Owner's Manual at [dell.com/support/manuals](http://dell.com/support/manuals).

 **CAUTION:** Correctly preparing the PowerVault Modular Disk (MD) storage array is critical for successfully configuring your NAS solution.

 **NOTE:** The NAS solution does not monitor the health of the MD array therefore, it is highly recommended that you set up SMTP E-mail alerts on the MD storage array to be cautioned in case of failures that can impact data availability.

 **NOTE:** PowerVault MDSM is available for download on [dell.com/support](http://dell.com/support).

 **NOTE:** See the MD storage array documentation at [dell.com/support/manuals](http://dell.com/support/manuals).

 **NOTE:** Additional configuration is required after completing the steps in the PowerVault Configuration Utility.

 **NOTE:** Challenge Handshake Authentication Protocol (CHAP) must be disabled on PowerVault MD storage arrays and the storage array must be configured for two logical SANs, (i.e. iSCSI ports 0 should reside on SAN A and iSCSI ports 1 should reside on SAN B).

Use the PowerVault MDSM to complete the following tasks:

1. Enabling jumbo frames on the MD storage array.
2. Create disk groups.  
For more information see, [Creating Disk Groups](#).
3. Create virtual disk pairs.  
For more information see, [Creating Virtual Disks](#).
4. Create hosts and host group.
5. Map the virtual disks to the host group.

 **NOTE:** In addition to disk groups, the PowerVault MDSM supports disk pools. If you prefer to use a disk pool, follow the best practices available in the MD documentation for configuring the disk pools.

## MD Topology

Your PowerVault MD32x0i array is equipped with eight iSCSI ports across two controllers. You can configure the MD32x0i array for your solution to serve both NAS and Block. MD32x0i controllers have four iSCSI data ports. Note the following when configuring the ports:

- All four iSCSI host ports must be configured to use different individual subnets.

- Two of the four iSCSI host ports can be used for additional block level iSCSI access by other hosts.

 **NOTE:** The NX3600 connects to two of the four ports configured.

## Enabling Jumbo Frames On The MD Storage Array

To enable jumbo frames on all the iSCSI ports on the MD storage array:

1. In the PowerVault MDSM, select the **Hardware** tab.
2. Right-click the relevant controller.
3. Select **Configure** → **iSCSI Ports**.  
The **Configure iSCSI Ports** screen is displayed.
4. Click **Advanced Port Settings**.  
The **Advanced Port Settings** screen is displayed.
5. Select **Enable jumbo frames**.
6. In MTU size enter, 9000.
7. Enable jumbo frames for each iSCSI port on the MD storage array.

 **NOTE:** On MD32x0i arrays, the configuration is done on ports dedicated to NAS.

## Considerations When Creating Disk Groups And Virtual Disks

Consider the following when creating disk groups and virtual disks.

### One Disk Group (RAID 6), One Hot Spare

#### Space

This option consists of one RAID 6 disk group with two virtual disks and a single hot spare. The single RAID 6 disk group is made up of eleven, 2 TB hard drives. In RAID 6, the total available space for virtual disks is 18 TB as two hard drives are allocated for parity. The NAS cluster requires pairs of equal sized virtual disks. Therefore, the disk group is divided into two 9 TB virtual disks to evenly utilize all available space in the disk group. You now have 18 TB space to allocate for the NAS cluster.

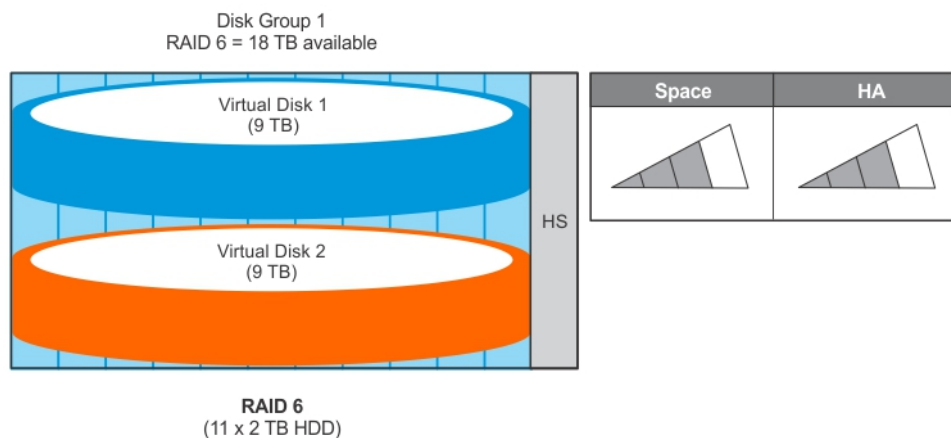

#### High Availability

A RAID 6 disk group can continue to execute read and write requests to all its virtual disks after any two concurrent disk failures. As long as there is enough time to rebuild between

failures, with the hot spare, there can be three concurrent disk drive failures before read and write requests cannot be executed.

## One Disk Group (RAID 1/10), One Hot Spare

### Space

This option consists of one RAID 1/10 disk group with two virtual disks and a single hot spare. The single RAID 1/10 disk group is made up of eleven, 2 TB hard drives. In RAID 1/10, the total space available for virtual disks is 10 TB as the usable capacity is half of the physical disks in the disk group. The NAS cluster requires pairs of equal sized virtual disks. Therefore, the disk group is divided into two 5 TB virtual disks evenly utilizing all available space. You have 10 TB space to be allocated for the NAS cluster.

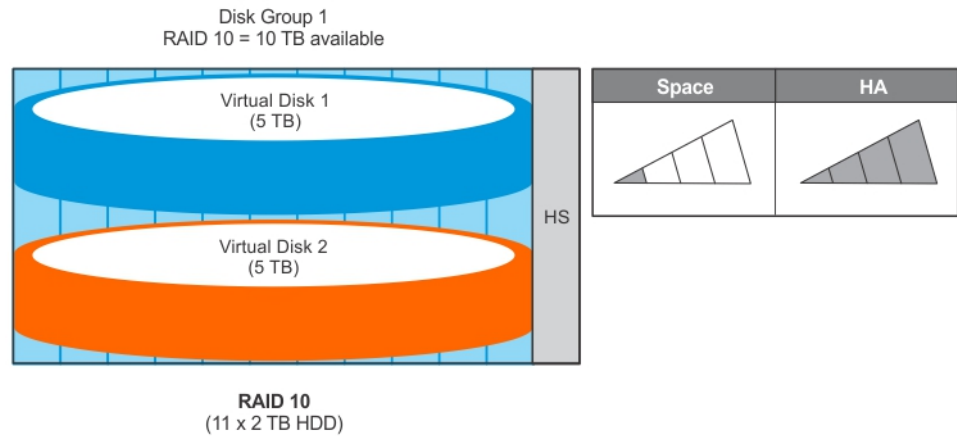

### High Availability

In a RAID 1/10 disk group, the disks are striped and mirrored, providing the best data availability. A RAID 1/10 disk group can continue to execute read and write requests to all its virtual disks in the event of a failure of half the physical disks.

## Two Disk Groups (RAID 5), Two Hot Spares

### Space

This option consists of two RAID 5 disk groups with a single virtual disk in each group and two hot spares. Each RAID 5 disk group is made up of five, 2 TB hard drives. In RAID 5, the available space in each disk group is 8 TB as one hard disk is allocated for parity. The NAS cluster requires pairs of equal sized virtual disks. Therefore, each disk group is divided into a single 8 TB virtual disk utilizing all available space in its disk group. You have 16 TB space to be allocated for the NAS cluster.

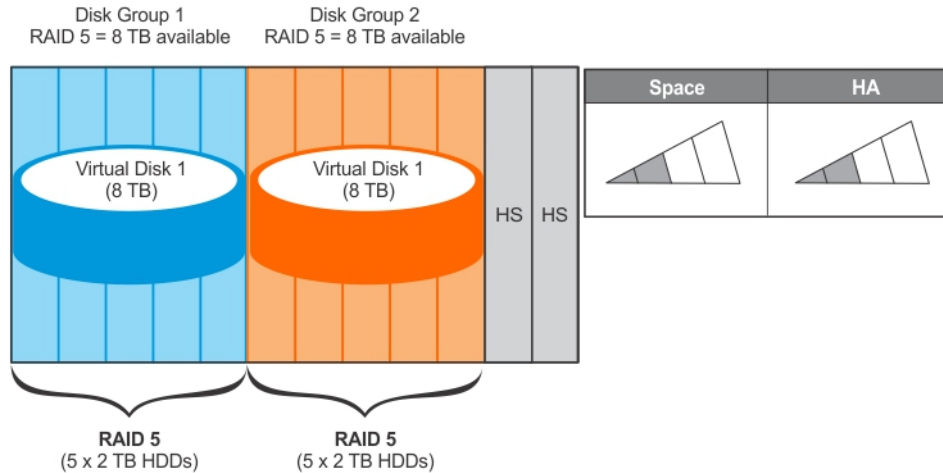

### High Availability

A RAID 5 disk group can continue to execute read and write requests to all its virtual disks after a single disk failure. As long as there is enough time to rebuild between failures, with hot spares, there can be three disk drive failures before read and write requests cannot be executed.

## Two Disk Groups (RAID 6), Zero Hot Spares

### Space

This option consists of two RAID 6 disk groups with a single virtual disk in each group and no hot spares. Each RAID 6 disk group is made up of six, 2 TB hard drives. In RAID 6, the available space in each disk group is 8 TB as two hard disks are allocated for parity. The NAS cluster requires pairs of equal sized virtual disks. Therefore, each disk group is divided into a single 8 TB virtual disk utilizing all available space in its disk group. You have 16 TB space to be allocated for the NAS cluster.

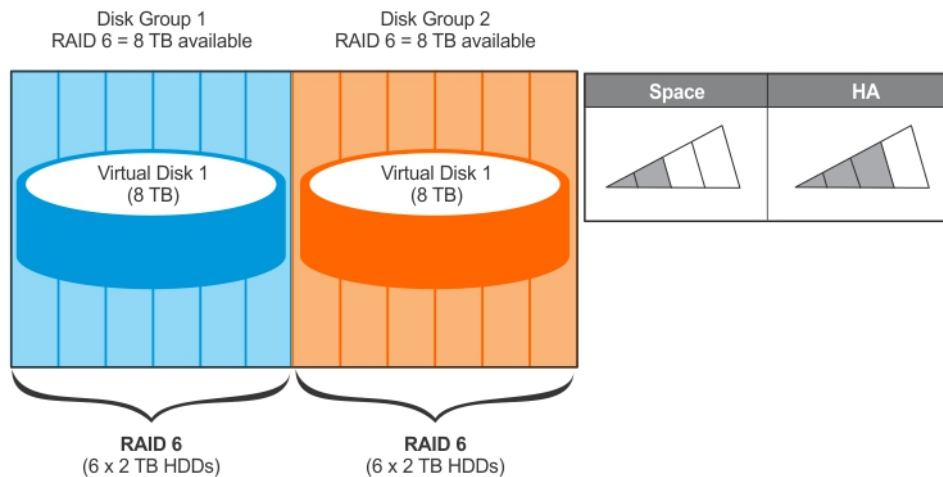

### High Availability

A RAID 6 disk group can continue to execute read and write requests to all of its virtual disks after any two concurrent disk failures. Since the physical disks are split between two disk groups, data can continue to be read and written if four concurrent disks fail, as long as no more than two fail in each disk group.

## One Disk Group (RAID 5), One Hot Spare

**CAUTION:** Due to the large capacity and number of physical disks, the limitation to this option is the rebuild time. If two disks fail simultaneously, data loss may occur.

### Space

This option consists of one RAID 5 disk group with two virtual disks and a single hot spare. The disk group is made up of eleven, 2 TB physical disks with a total size of 20 TB. The NAS cluster requires pairs of equal sized virtual disks. Therefore, the disk group is divided into two 10 TB virtual disks to evenly utilize all available space in the disk group. You have 20 TB space to be allocated for the NAS cluster.

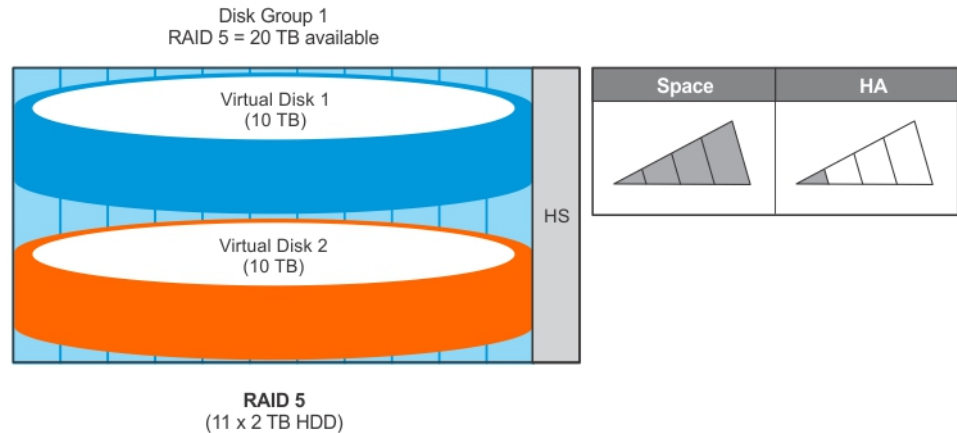

### High Availability

A RAID 5 disk group can continue to execute read and write requests to all its virtual disks after a single disk failure. As long as there is enough time to rebuild between failures, with the hot spare, there can be two disk failures before read and write requests cannot be executed.

## Creating Disk Groups

You can create disk groups either automatically or manually using the PowerVault MDSM.

### Creating Disk Groups Automatically

**NOTE:** The following steps apply to PowerVault MDSM versions 10.84.x6.25 and later.

To create disk groups automatically:

1. Launch the PowerVault MDSM software on the management station.
2. Select the MD storage array you plan to use for your NAS storage.
3. Start the **Create Disk Group Wizard** using one of the following methods:
  - On the **Storage & Copy Services** tab, select **Unconfigured Capacity** and then select **Create Disk Group** from the pop-up menu. In version 10.80.x6.47 of the PowerVault MDSM, on the **Logical** tab, select **Unconfigured Capacity** or right-click **Unconfigured Capacity** and select **Create Disk Group** from the pop-up menu.
  - On the **Hardware** tab, select one or more unassigned physical disks of the same physical disk type, or right-click the unassigned physical disk and select **Create Disk Group** from the pop-up menu. In version 10.80.x6.47 of the PowerVault MDSM, on the **Physical** tab, select one or more unassigned physical disks of the same physical disk type or right-click the unassigned physical disks and select **Create Disk Group** from the pop-up menu.

The **Introduction (Create Disk Group)** window is displayed.

4. In the **Introduction (Create Disk Group)** window, click **Next**.

The **Disk Group Name & Physical Disk Selection** window is displayed.

5. Type a name for the disk group in **Disk Group Name**.

It is recommended that you use the name of the NAS cluster appended by disk group and number for the disk group name. For example, *NX3600-Disk-Group-0*.

 **NOTE:** The disk group name must not exceed 30 characters.

6. In **Physical Disk selection**, select **Automatic** and click **Next**.

The **RAID Level and Capacity** screen is displayed.

7. In the **RAID Level and Capacity** window, select the appropriate RAID level from the **RAID level** list.

You can select RAID levels 1/10, 5, or 6. Depending on the RAID level chosen, the physical disks available for the selected RAID level are displayed in the **Select Capacity** table.

8. In the **Select Capacity** table, select the preferred disk group capacity, and click **Finish**.

The **Disk Group Created** screen is displayed. If you are going to use two disk groups, repeat the procedure and then proceed to [Creating Virtual Disks](#).

 **NOTE:** If you select **Yes** in the **Disk Group Created** screen, the **Introduction (Create Virtual Disk)** screen is displayed. Proceed to step 4 of [Creating Virtual Disks](#).

## Creating Disk Groups Manually

To create disk groups manually:

1. Launch the PowerVault MDSM software on the management station.
2. Select the MD storage array you plan to use for your NAS storage.
3. Start the **Create Disk Group Wizard** using one of the following methods:
  - On the **Storage & Copy Services** tab, select **Unconfigured Capacity** and select **Create Disk Group** from the pop-up menu. In version 10.80.x6.47 of the PowerVault MDSM, on the **Logical** tab, select **Unconfigured Capacity** or right-click **Unconfigured Capacity** and select **Create Disk Group** from the pop-up menu.
  - On the **Hardware** tab, select one or more unassigned physical disks of the same physical disk type, or right-click the unassigned physical disk and select **Create Disk Group** from the pop-up menu. In version 10.80.x6.47 of the PowerVault MDSM, on the **Physical** tab, select one or more unassigned physical disks of the same physical disk type or right-click the unassigned physical disk and select **Create Disk Group** from the pop-up menu.

The **Introduction (Create Disk Group)** window is displayed.

4. In the **Introduction (Create Disk Group)** window, click **Next**.

The **Disk Group Name & Physical Disk Selection** window is displayed.

5. Type a name for the disk group in **Disk group name**.

It is recommended that you use the name of the NAS cluster appended by disk group and number for the **Disk group name**. For example, *NX3600-Disk-Group-0*.

 **NOTE:** The disk group name must not exceed 30 characters.



6. In **Physical Disk selection** choices select **Manual** and click **Next**.

The **RAID Level and Capacity** screen is displayed.



7. In the **RAID Level and Capacity** window, select the appropriate RAID level from the **RAID level** list.

You can select RAID levels 1/10, 5, or 6. Depending on the RAID level chosen, the physical disks available for the selected RAID level are displayed in **Unselected Physical Disks** table.



8. In the **Unselected Physical Disks** table, select the relevant disk group capacity, and click **Add**.  
 **NOTE:** You can select multiple physical disks at the same time by holding **Ctrl** or **Shift** and selecting additional physical disks.  
To view the capacity of the new disk group, click **Calculate Capacity**.
9. Click **Finish**.  
The **Disk Group Created** screen is displayed. If you are going to use two disk groups, repeat step 3 to step 9 and then proceed to [Creating Virtual Disks](#).  
 **NOTE:** If you select **Yes** in the **Disk Group Created** screen, the **Introduction (Create Virtual Disk)** screen is displayed. Proceed to step 4 of [Creating Virtual Disks](#).

## Creating Virtual Disks Using PowerVault MDSM

-  **NOTE:** Create a minimum of two virtual disks of the same size dedicated for the NAS storage. The NAS storage capacity can be expanded to up to 32 virtual disks and the number of virtual disks must increment in pairs.
-  **NOTE:** Minimum virtual disk size is 125 GB. Although the MD allows larger virtual disks, the maximum size supported by the NX3600/NX3610 is 32 TB.

### For Version 10.80.x6.47 And Earlier

To create virtual disks using PowerVault MDSM version 10.80.x6.47 and earlier:

1. Launch the **PowerVault MDSM**.
2. Click **Virtual Disk** in the top menu.  
The **Create Virtual Disk: Specify Parameters** screen is displayed.
3. Click **Create**. The **Introduction (Create Virtual Disk)** screen is displayed.  
 **NOTE:** The size of the virtual disk must be equal to or less than the free capacity.
4. Click **Next**. The **Specify Capacity/Name** screen is displayed.
5. In **New virtual disk capacity**, enter the size of the virtual disk.
6. Enter a relevant name for the virtual disk in the **Virtual Disk** name field.
7. Click **Finish**.  
The **Create Successful (Create Virtual Disk)** screen is displayed.
8. Click **Yes** to create a new virtual disk.  
The **(Allocate Capacity Create Virtual Disk)** screen is displayed.
9. Repeat step 5 to step 8 to create the second virtual disk.  
The disk size must be the same as the first virtual disk.

### For Version 10.84.x6.25 And Later

To create virtual disks using PowerVault MDSM version 10.84.x6.25 and later:

1. Launch the **PowerVault MDSM**.
2. On the **Logical** tab, right-click **Free Capacity** in the disk group you created and select **Create Virtual Disk**.  
The **Create Virtual Disk: Specify Parameters** screen is displayed.
3. In **New virtual disk capacity**, enter the size of the virtual disk.

**Introduction (Create Virtual Disk)** screen is displayed.

 **NOTE:** The size of the virtual disk must be equal to or less than the free capacity.

4. In the **Virtual Disk** name field, enter a relevant name for the virtual disk.
5. Click **Next**.  
The **Specify Capacity/Name** screen is displayed.
6. In the **Map to host** field, select **Map Later**.
7. In the **Virtual Disk I/O characteristics type** field, select **File system (typical)**.
8. Click **Finish**.  
The **Create Virtual Disk – Completed** screen is displayed.
9. Click **Yes** to create a new virtual disk.  
The **Create Virtual Disk: Specify Parameters** screen is displayed.
10. Repeat steps 3 to step 7 to create the second virtual disk.  
The disk size must be the same as the first virtual disk.

## Creating A Host Group

To create a host group:

1. Launch the PowerVault MDSM and select the MD storage array you plan to use for your NAS storage.
2. Select the **Host Mappings** tab. In version 10.80.x6.47 of the PowerVault MDSM, select the **Mappings** tab.
3. In the **Topology** pane, select the storage array or the **Default Group**.
4. Access the **Define Host Group** screen by following any one of the steps below:
  - In version 10.80.x6.47 of the PowerVault MDSM, select the **Mappings** → **Define** → **Host Group** tab.
  - In the current version, select **Host Mappings** → **Define** → **Host Group** .
  - Right-click the storage array or the **Default Group**, and select **Define** → **Host Group** from the pop-up menu.

The **Define Host Group** screen is displayed.

5. Type the name of the new host group in **Enter New Host Group Name** .  
For example, *PowerVault\_NX3600*.

 **NOTE:** Host group name must not exceed 30 alphanumeric characters.

 **CAUTION:** No host other than the NX3600/NX3610 controllers must be added to this host group. If other hosts are added to this host group, there may be data corruption.

6. Click **OK**.  
The mappings are saved. The **Topology** pane and the **Defined Mappings** pane in the **Mappings** tab are updated to reflect the mappings.

## Creating A Host

To create a host in the host group:

1. In the PowerVault MDSM, right-click the host group you created.
2. Click **Define** → **Host**.  
The **Specify Host Name (Define Host)** screen is displayed.
3. Type the name of the new host in **Host name**.
4. Click **Next**.

The **Specify Host Port Identifiers (Define Host)** screen is displayed.

5. Select the host port identifier from the **Add by selecting a known unassociated host port identifier** list.
6. Type the host name in **User label** and suffix the host name with IQN.
7. Click **Add**.
8. Click **Next**.

The **Specify Host Type (Define Host)** screen is displayed.

9. Select **Linux** from the **Host type (operating system)** list.
10. Click **Next**.

The **Preview (Define Host)** screen is displayed.

11. Click **Finish**.

The **Creation Successful (Define Host)** screen is displayed.

12. Click **Yes** to define another host.

Repeat step 2 to step 10 to create another host. A host must be created for each NAS controller that is a member of the cluster.

## Adding Virtual Disks To A Host Group

To add virtual disks to a host group:

1. In the PowerVault MDSM, right-click the host group you created.
2. Select **Add LUN Mapping**.  
In version 10.80.x6.47 of the PowerVault MDSM, select **Define** → **Additional Mapping**.
3. Click **Define** → **Additional Mapping**.  
The **Define Additional Mapping** screen is displayed.
4. In **Host group or host**, select the host group you created in the [Creating A Host Group](#) section.
5. In the **Logical Unit Number** field, select a LUN.  
The supported LUNs are 0 through 255.
6. In the **Virtual Disk** field, select the first virtual disk that you created.
7. Click **Add**.  
The virtual disk you selected is added and the **Logical unit number (LUN) (0–255)** list is populated.
8. Select the second virtual disk from the **Virtual Disk** list.
9. Click **Add**.  
The second virtual disk you selected is added and the **Logical unit number (LUN) (0–255)** list is populated.
10. Click **Close**.

## Accessing The NAS Manager Web Interface



To access the NAS Manager web interface:

1. Enter the NAS Management VIP address you specified in the NAS IDU in an Internet browser.

 **NOTE:** The **Security Alert** window is displayed after you install the PowerVault NAS cluster solution, or after upgrading the system. Clicking **Yes** enables the current session. Clicking **View Certificate** enables all future sessions.

The **Security Alert** window is displayed.

2. Click **View Certificate**.

3. Click **Install Certificate**.  
The **Certificate Import Wizard** is displayed.
4. Click **Next**.  
The **Certificate Store** screen is displayed.
5. Verify that **Automatically select the certificate store based on the type of certificate** is selected and click **Next**.  
The **Completing the Certificate Import Wizard** screen is displayed.
6. Click **Finish**.  
A message prompts you that the certificate is imported successfully.
7. Click **OK**.  
The certificate window is displayed.
8. In the **Certificate** window, click **OK**.
9. Type the **username** and **password** and click **Log in**.
  -  **NOTE:** Use **admin** as the username. The default password is **Stor@ge!**. You can change the password later.
  -  **NOTE:** If the **Start Configuration** page does not open automatically, click **Cluster Management** → **Maintenance** → **Start Configuration Wizard**.

# Running The NAS Manager Configuration Wizard

The **NAS Manager Configuration Wizard** is the final step in completing the PowerVault NAS cluster solution configuration and integrating the solution into the environment. In addition to formatting and starting the file system, you can set up the DNS, time management, user identification, authentication parameters, and monitoring options.

You can leave the wizard at any time by selecting another page from the navigation pane. Every page in the configuration wizard can also be accessed from the navigation pane. This means that you can modify the system's configuration parameters directly, by accessing the appropriate page from the navigation pane, without having to run the entire wizard.

 **NOTE:** The **Start Configuration Wizard** in the **NAS Manager** opens automatically when you click **Finish** in the **NAS IDU**.

## Configuring DNS

To configure the DNS:

1. Launch the PowerVault NAS Manager.
2. From the navigation pane, select **Cluster Management** → **Maintenance** → **Start Configuration Wizard**. The **Configuration Wizard (DNS Configuration) step 1 of 14** screen is displayed.
3. Enter the **DNS server** IP address and the **DNS suffix**.  
 **NOTE:** You can add additional DNS servers and DNS suffixes by clicking **Add DNS server** and **Add DNS suffix**.
4. Click **Next**.  
The **Configuration Wizard (Time Configuration) step 2 of 14** screen is displayed.

## Configuring NTP

To configure NTP enter a time zone for the NAS solution and choose whether to sync the cluster time with an NTP server (recommended) or enter time manually.

1. In the **Configuration Wizard (Time Configuration) step 2 of 14** screen, select the appropriate **Time zone** from the list.
2. Select **Time should be synchronized with an NTP server** and enter the **NTP server** IP address.  
If no NTP servers exist in the environment, select **There is no NTP server to synchronize time with** and enter the time and date manually.  
 **NOTE:** You must use an NTP server. If the clients and the NAS cluster get out of sync for more than five minutes, the clients cannot connect to the cluster.
3. Click **Next**.  
The **Configuration Wizard (E-mail Configuration) step 3 of 14** screen is displayed.

## Configuring SMTP

 **NOTE:** It is highly recommended that you configure an SMTP server for e-mail alerts in case of issues with the cluster solution.

To configure SMTP:

1. In the **Configuration Wizard (E-mail Configuration) step 3 of 14** screen, click **Add SMTP server**.  
The **Configuration Wizard (Add SMTP server) step 3 of 14** is displayed.
2. In **Mail server or relay**, add the SMTP server address.
3. In **Description**, enter the description for the SMTP server and click **Save Changes**.

 **NOTE:** If your SMTP server requires authentication, enter the **User name** and **Password** to access the SMTP server.

The **Configuration Wizard (SNMP Configuration) step 4 of 14** screen is displayed.

## Configuring SNMP

To configure SNMP enter the IP address of the trap recipient and the filters for the minimum severity event that triggers a trap to be sent for the various categories.

1. In the **Configuration Wizard (SNMP Configuration) step 4 of 14** screen, enter appropriate values for the following:
  - a) **System contact**
  - b) **System location**
  - c) **Read community**
  - d) **Trap recipient**

 **NOTE:** Click **Add** to add multiple **Trap** recipients.

2. Click **Next**.

The **Configuration Wizard (File System Format) step 5 of 14** screen is displayed.

 **NOTE:** There may be a delay before the screen is displayed since the system is attempting to discover all LUNs (MD virtual disks) assigned to the NAS cluster.

## Formatting And Starting The File System

Ensure all virtual disks that were added to the host group in [Adding Virtual Disks To A Host Group](#) section are listed and accessible by all controllers in the cluster.

To format the file system:

1. In the **Configuration Wizard (File System Format) step 5 of 14** screen, click **Next**.

 **NOTE:** Ensure that LUNs are assigned for each controller. The LUNs should be of the same size and visible to all controllers. If the LUNs are not visible to all controllers, see [Troubleshooting LUNs](#).

The following message is displayed: **Are you sure you want to format the file system?**

2. Click **OK**.

Depending on the total size and number of LUNs assigned to the NAS cluster this step may take several minutes to complete.

A message confirming that the file system has been formatted is displayed.

3. Click **Next**.  
The **Configuration Wizard (System Stop/Start) step 6 of 14** screen is displayed.  
You can choose to start the file system at this time or start it later by skipping this step. The file system must be started in order to serve up files and shares.
4. To start the file system, click **Next**.  
The **Configuration Wizard (Change Passwords) step 7 of 14** screen is displayed.

## Creating and Changing Admin Passwords

By default, the Local CIFS Administrator password is randomized and needs to be set before CIFS shares can be managed. It is highly recommended that you change the local admin password.

 **NOTE:** To change the admin password or the CIFS Administrator password, you must enter the default admin password. The default admin password is **Stor@ge!**.

In the **Configuration Wizard (Change Passwords) step 7 of 14**, click **Next**. The **Configuration Wizard (System Identity) step 8 of 14** screen is displayed.

## Joining The File System To A Windows Active Directory Domain

To join the file system to a Windows Active Directory domain, enter a cluster name. If the cluster is a member of a Microsoft windows network, enter a NetBIOS name and the domain it belongs to.

1. In the **Configuration Wizard (System Identity) step 8 of 14** screen, select **The system is a member in a Microsoft Windows network** to connect the file system to a Windows active directory.
2. Enter appropriate values for the following:
  - a) **System NetBIOS name**
  - b) **Domain**
  - c) **User name**
  - d) **Password**

 **NOTE:** The credentials you enter for **User name** and **Password** must have domain administrator rights to join the domain.

3. Click **Next**.  
The following message is displayed: **Saving changes will cause CIFS clients to be disconnected. Do you wish to continue?**
4. Click **OK**.  
The **Configuration Wizard (CIFS Protocol Configuration) step 9 of 14** screen is displayed.

## Configuring The CIFS Protocol

If you want to create CIFS shares, the **Allow CIFS Access** check box must be checked. To prevent CIFS access, the check box must be unchecked. Enter a system description; this is the name that is displayed in windows explorer title:

1. In the **Configuration Wizard (CIFS Protocol Configuration) step 9 of 14** screen, enable **Allow clients to access files via the CIFS protocol** and enter an appropriate description in **System description**.
2. Select **Authentic users' identity via Active Directory and local users database** to configure the Active Directory security mode.  
If Active Directory authentication is not needed, select **Authenticate users' identity via local users database**.

3. Click **Next**.

The **Configuration Wizard (Identity Management Database) step 10 of 14** screen is displayed.

## Providing UNIX Identity Database Values

The NAS solution supports NIS and LDAP for UNIX user identity management. To provide UNIX identity database values:

1. In the **Configuration Wizard (Identity Management Database) step 10 of 14** screen, select the appropriate UNIX identity database. If NIS and LDAP are not used in the environment, select **Users are not defined in an external user database**.
2. Click **Next**.  
The **Configuration Wizard (Cross-protocol User Mapping) step 11 of 14** screen is displayed.

## Mapping Users Automatically

To automatically map users in Active Directory to users in the UNIX user repository:

1. In the **Configuration Wizard (Cross-protocol User Mapping) step 11 of 14** screen, select **Map users in Active Directory to users in the UNIX repository automatically**.

 **NOTE:** By default, **Map unmapped users to the guest account** is selected.

2. Click **Next**.  
The **Configuration Wizard (NAS Volumes Configuration) step 12 of 14** screen is displayed.

## Creating NAS Volumes

NAS volumes can be created with file access security styles of NTFS, UNIX, or mixed. Due to security concerns, it is highly recommended to choose NTFS or UNIX unless mixed is absolutely necessary. Most security concerns in a mixed Windows/Unix environment can be fully addressed by using either NTFS or UNIX file system security modes in conjunction with User Mapping.

 **NOTE:** If you create NAS volumes with file access security styles of NTFS you can still manage and access an UNIX file system and vice-versa.

1. In the **Configuration Wizard (NAS Volumes Configuration) step 12 of 14** screen, click **Add** to define NAS volumes.
2. Enter appropriate values for the following:
  - a) **NAS Volume**
  - b) **NAS volume allocated space**
  - c) **Alert when used space reaches**
  - d) **Send email events to administrator**
  - e) **Access time granularity**
  - f) **File access security style**
3. Click **Save Changes**.  
The new NAS volume is added.

 **NOTE:** Repeat this procedure to define more NAS volumes.

4. Click **Next**.  
The **Configuration Wizard (Add CIFS Shares) step 13 of 14** screen is displayed.



## Creating CIFS Shares

To create CIFS shares:

1. In the **Configuration Wizard (Add CIFS Shares) step 13 of 14** screen, select the volume from the **NAS Volume** list to add CIFS Share.
2. Select either **General-access share** or CIFS share, containing a user-based directory tree and enter the appropriate information.

 **NOTE:** You cannot add a CIFS share if a shared folder is not created.

3. Click **Save Changes**.  
A CIFS share is created and the **Configuration Wizard (CIFS Shares) step 13 of 14** screen is displayed.

 **NOTE:** Click **Add** and repeat this procedure to add more CIFS shares to a NAS volume.

4. Click **Next**.  
The **Configuration Wizard (NFS Exports) step 14 of 14** screen is displayed.

## Creating NFS Exports

 **NOTE:** You must create an NFS export only if you have a UNIX client.

1. In the **Configuration Wizard (NFS Exports) step 14 of 14** screen do one of the following: , otherwise **Next** and skip to final step of completing the **Configuration Wizard**.
  - Click **Add**.
  - Click **Next** to skip to the final step.
2. Select the volume from the **NAS Volume** list.
3. To create an NFS export from an existing shared folder, click the **Browse icon** and navigate to the appropriate folder and select the directory from the **Exported directory** list.
4. To create a new NFS export, in **Exported directory** enter the name for the NFS export. Select **Create the exported directory if it does not exist**.
5. Define the client machines that are allowed access to the NFS export by selecting one of the following:
  - **All Client Machines**
  - **A single Client Machine**
  - **All Client Machines in a specific network**
  - **All Client Machines in a specific netgroup**
6. Click **Save Changes**.  
The **Configuration Wizard (NFS export) step 14 of 14** screen with the existing NFS exports is displayed.
7. To add additional NFS exports, click **Add** and repeat this procedure.
8. Click **Next**.  
The system **Configuration Wizard** is complete.

## Configuring Additional Client VIPs

 **NOTE:** If the client network is routed to get to the FluidFS cluster, one client VIP is needed for each port. Each appliance can have up to four VIPs. If the client network is not routed to get to the FluidFS cluster, only one client VIP is needed.

To configure additional client VIPs:

1. Select **Cluster Management** → **Network** → **Subnets**.  
The **Subnets** screen displays all the available subnets.
2. Click the **Primary** subnet.  
The **Add/Edit Subnet** screen is displayed.
3. In **VIP address**, add additional client VIP addresses, as required.  
 **NOTE:** If you need more than four VIPs, click **Add VIP**.
4. Click **Save Changes**.

## Troubleshooting LUNs

To ensure that the LUNs are available to all controllers:

1. Verify if the correct NAS controller IQN is entered in the PowerVault MD Storage Manager (MDSM).  
 **NOTE:** A common issue can be a preceding or trailing space. To view the IQNs of the controllers, via the NAS command line enter the command `system maintenance luns configuration iscsi-view`.
2. Ensure all hosts are part of the host group in the MDSM.
3. Ensure all virtual disks are mapped to the host group in the MDSM.
4. Verify from the NAS command line that the correct IP was entered as the discovery IP for the MD storage array.  
To view the iSCSI discovery IP, enter `system maintenance luns configuration iscsi-view`.  
To change the iSCSI Discovery IP, type `system maintenance luns configuration iscsi-set - iSCSIDiscoveryIPs <iSCSI Discovery IP> None None` where, <iSCSI Discovery IP> is the iSCSI port IP of the MD storage array.

# PowerVault FluidFS NAS Setup Worksheet

Complete the worksheet to record the layout of your PowerVault FluidFS NAS. Use this worksheet while performing the network configuration steps in the NAS IDU.

Switch Requirements Checklist		
	Client/Primary Network	SAN Network
<b>Jumbo Frames Enabled (9216 MTU)</b>	<input type="checkbox"/> Recommended	<input type="checkbox"/> Required
<b>Port Fast Enabled</b>	<input type="checkbox"/> Required	<input type="checkbox"/> Required
<b>Flow Control Enabled</b>	<input type="checkbox"/> Recommended	<input type="checkbox"/> Required
<b>IPv6 Enabled</b>	<input type="checkbox"/> Required (during initial deployment)	<input type="checkbox"/> Required

Number of NAS Appliances		Number of MD-series Arrays		Type of Network	
<input type="radio"/> 1	<input type="radio"/> 2	<input type="radio"/> 1	<input type="radio"/> 2	<input type="radio"/> Routed	<input type="radio"/> Flat
<i>NAS Appliance 0 Service Tag:</i>					
<i>NAS Appliance 1 Service Tag:</i>					
<i>NAS Cluster Name:</i>					

Primary Client Network	
<i>NAS Management VIP:</i>	
<i>Client Access VIP:</i>	
<i>Gateway:</i>	
<i>Subnet Mask:</i>	
<b>NAS Appliance 0</b>	
<i>Controller 0 IP:</i>	<i>Controller 1 IP:</i>
<b>NAS Appliance 1</b>	
<i>Controller 2 IP:</i>	<i>Controller 3 IP:</i>
<b>MD Array 0</b>	
<i>Controller 0, Management IP:</i>	<i>Controller 1, Management IP:</i>

<b>Primary Client Network</b>	
<b>MD Array 1</b>	
<i>Controller 0, Management IP:</i>	<i>Controller1, Management IP:</i>

<b>Interconnect (Private) Network</b>			
Select a private Class C subnet			
<input type="radio"/> 10.255.254.x	<input type="radio"/> 172.31.254.x	<input type="radio"/> 192.168.254.x	<input type="radio"/> _____.____.____.x

<b>NAS iSCSI Network</b>	
Network MTU	<input type="radio"/> 9000 (Jumbo Frames)
<i>Subnet Mask:</i>	
<b>SAN Network A</b>	
<i>NAS Appliance 0, Controller 0 IP:</i>	<i>NAS Appliance 1, Controller 2 IP:</i>
<i>NAS Appliance 0, Controller 1 IP:</i>	<i>NAS Appliance 1, Controller 3 IP:</i>
<b>SAN Network B</b>	
<i>NAS Appliance 0, Controller 0 IP:</i>	<i>NAS Appliance 1, Controller 2 IP:</i>
<i>NAS Appliance 0, Controller 1 IP:</i>	<i>NAS Appliance 1, Controller 3 IP:</i>

<b>MD-Series iSCSI Network (iSCSI Target Discovery Address)</b>	
Network MTU	<input type="radio"/> 9000 (Jumbo Frames)
<i>Subnet Mask:</i>	
<b>SAN Network A</b>	
<b>MD Array 0</b>	<b>MD Array 1</b>
<i>Controller 0, Port 0 iSCSI IP:</i>	<i>Controller 0, Port 0 iSCSI IP:</i>
<b>SAN Network B</b>	
<b>MD Array 0</b>	<b>MD Array 1</b>
<i>Controller 1, Port 1 iSCSI IP:</i>	<i>Controller 1, Port 1 iSCSI IP:</i>

# Getting Help

## Contacting Dell

 **NOTE:** Dell provides several online and telephone-based support and service options. If you do not have an active Internet connection, you can find contact information on your purchase invoice, packing slip, bill, or Dell product catalog. Availability varies by country and product, and some services may not be available in your area.

To contact Dell for sales, technical support, or customer-service issues:

1. Go to [dell.com/contactdell](http://dell.com/contactdell).
2. Select your country or region from the interactive world map.  
When you select a region, the countries for the selected regions are displayed.
3. Select the appropriate language under the country of your choice.
4. Select your business segment.  
The main support page for the selected business segment is displayed.
5. Select the appropriate option depending on your requirement.

## Documentation Feedback

If you have feedback for this document, write to [documentation\\_feedback@dell.com](mailto:documentation_feedback@dell.com). Alternatively, you can click on the **Feedback** link in any of the Dell documentation pages, fill up the form, and click **Submit** to send your feedback.